

FEATURES

Dec.2008

- * Current transfer ratio
(CTR : MIN. 50% at $I_F = 5\text{mA}$, $V_{CE} = 5\text{V}$)

- * Isolation voltage between input and output
($V_{iso} = 3\text{KV}_{rms}$)

- * Compact dual-in-line package
LTV-217: 1 channel type
LTV-227: 2 channels type
LTV-247: 4 channels type

- * Employs double transfer mold technology

- * Safety approved
FIMKO \ VDE approved
UL \ CUL under construction until Mar 2009.

- * ROHS compliance

Application

1. Computer terminals
2. System appliances, measurements.
3. Programmable logic controller
4. Signal transmission between circuits of different potentials and impedances.

OUTLINE DIMENSIONS

LTV-217 :

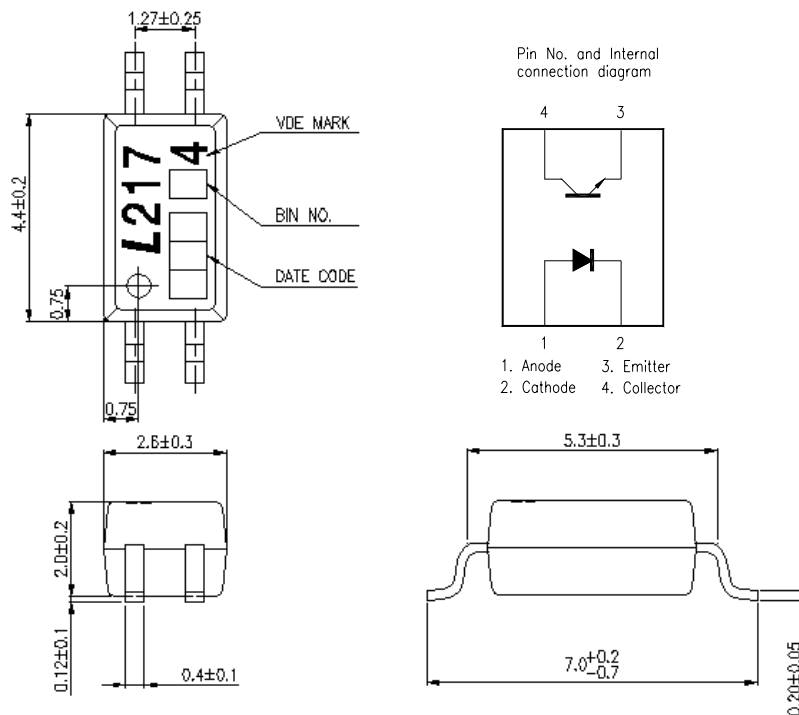

*1. 3-digit date code.

*2. Rank shall be or shall not be marked.

OUTLINE DIMENSIONS

LTV-227 :

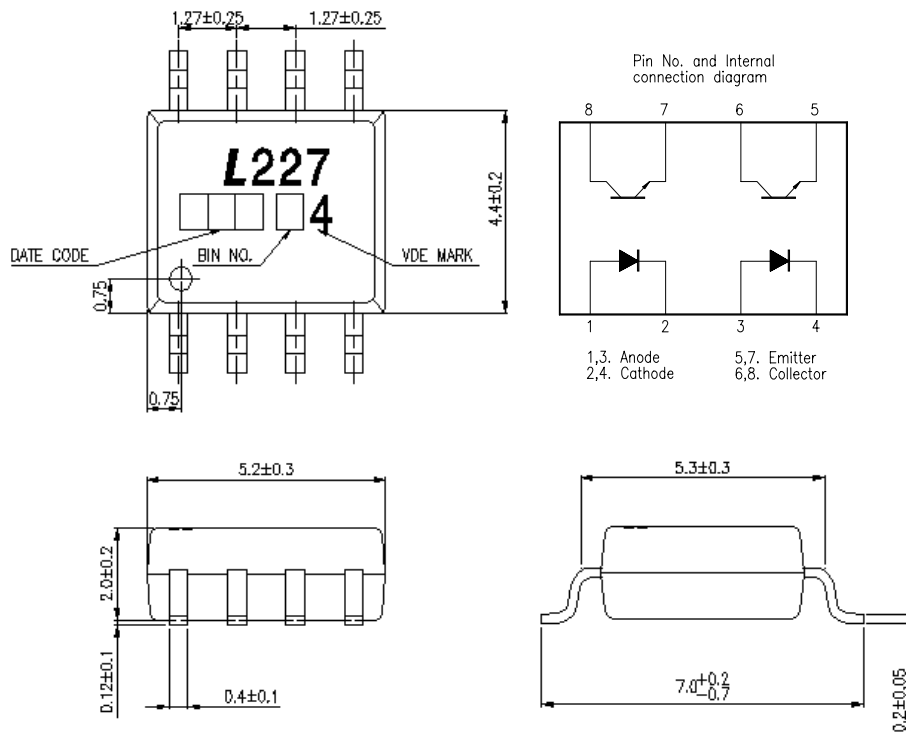

*1. 3-digit date code.

*2. Rank shall be or shall not be marked.

OUTLINE DIMENSIONS

LTV-247 :

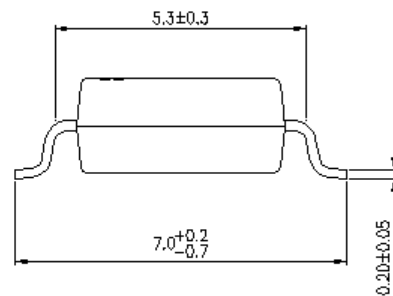
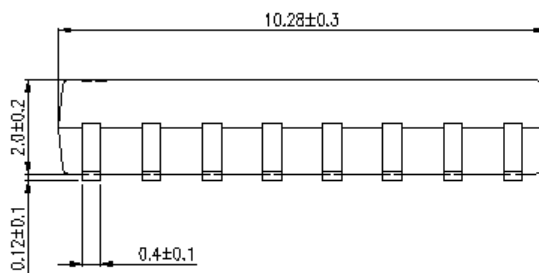
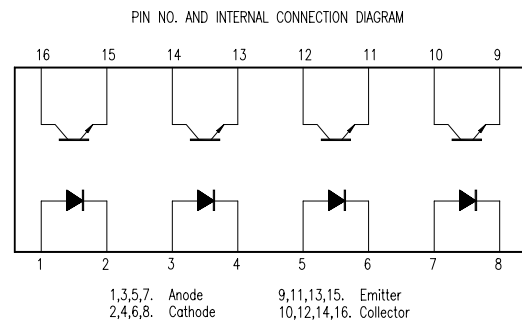
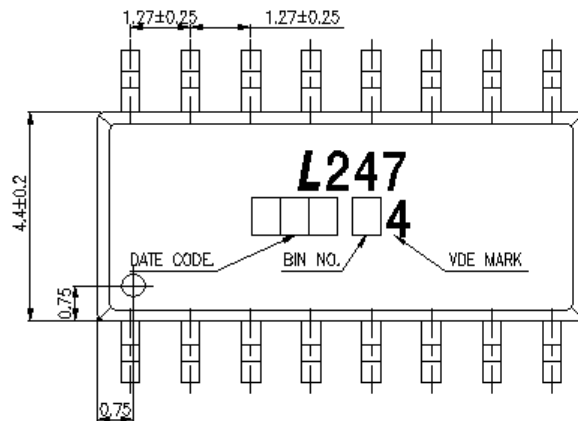

- *1. 3-digit date code.
- *2. Rank shall be or shall not be marked.

TAPING DIMENSIONS

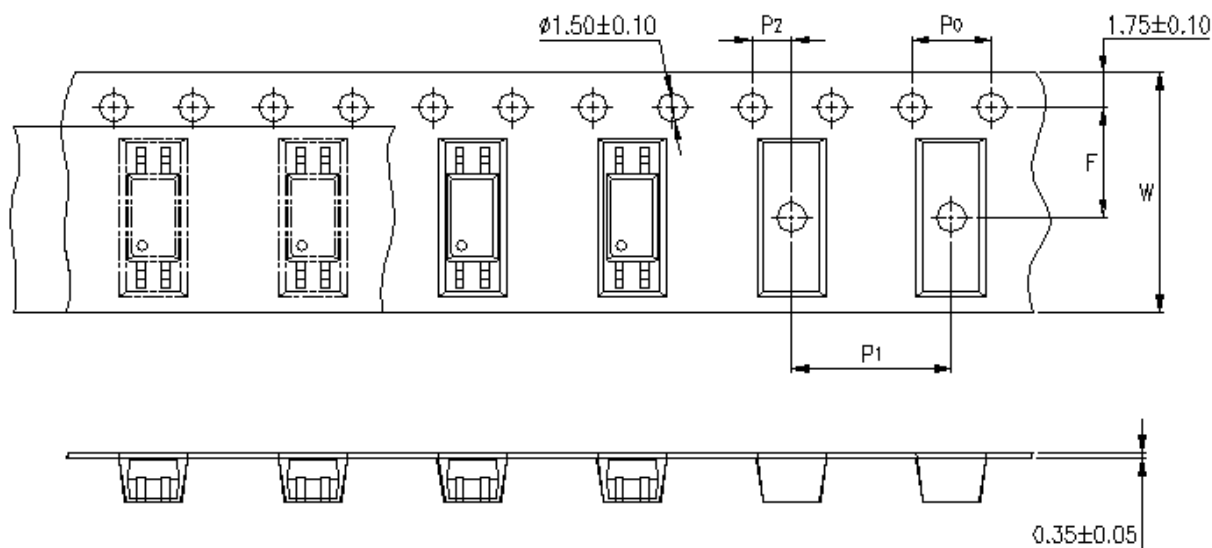

| Description | Symbol | Dimension in mm (inches) |
|--|----------------|--------------------------|
| Tape wide | W | 12 ± 0.3 (.47) |
| Pitch of sprocket holes | P ₀ | 4 ± 0.1 (.15) |
| Distance of compartment | F | 5.5 ± 0.1 (.217) |
| | P ₂ | 2 ± 0.1 (.079) |
| Distance of compartment to compartment | P ₁ | 8 ± 0.1 (.315) |

TAPING DIMENSIONS

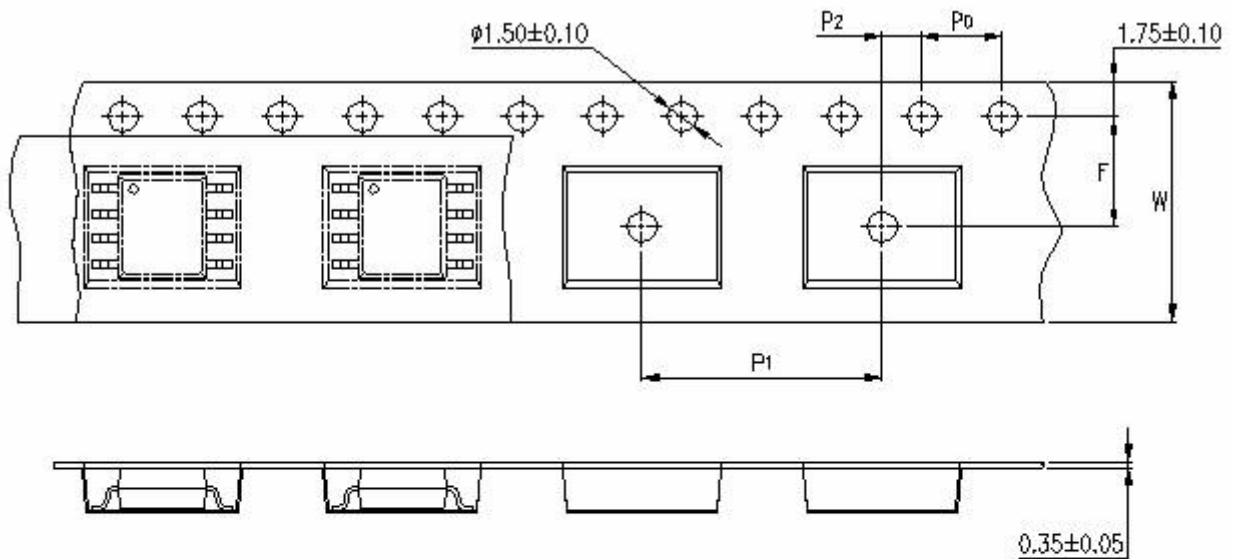

| Description | Symbol | Dimension in mm (inches) |
|--|------------|--|
| Tape wide | W | 12 ± 0.3 (.47) |
| Pitch of sprocket holes | P_0 | 4 ± 0.1 (.15) |
| Distance of compartment | F P_2 | 5.5 ± 0.1 (.217) 2 ± 0.1 (.079) |
| Distance of compartment to compartment | P_1 | 12 ± 0.1 (.315) |

TAPING DIMENSIONS

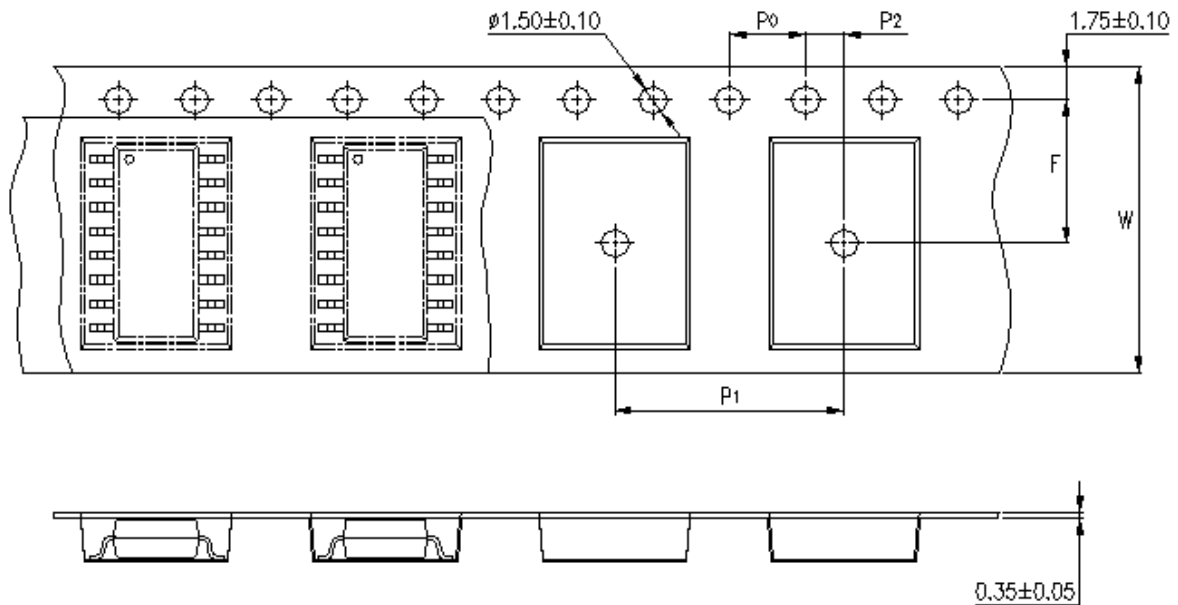

| Description | Symbol | Dimension in mm (inches) |
|--|----------------|--------------------------|
| Tape wide | W | 16 ± 0.3 (.47) |
| Pitch of sprocket holes | P ₀ | 4 ± 0.1 (.15) |
| Distance of compartment | F | 7.5 ± 0.1 (.217) |
| | P ₂ | 2 ± 0.1 (.079) |
| Distance of compartment to compartment | P ₁ | 12 ± 0.1 (.63) |

Quantities per Reel :

| Package Type | LTV-217 | LTV-227 | LTV-247 |
|------------------|---------|---------|---------|
| Quantities (pcs) | 3000 | 2000 | 2000 |

ABSOLUTE MAXIMUM RATING

(Ta = 25°C)

| PARAMETER | | SYMBOL | RATING | | | UNIT |
|-------------------------|-----------------------------|------------------|------------|-----|-----|------------------|
| | | | 217 | 227 | 247 | |
| INPUT | Forward Current | I _F | 50 | | | mA |
| | Reverse Voltage | V _R | 6 | | | V |
| | Power Dissipation | P | 70 | | | mW |
| OUTPUT | Collector - Emitter Voltage | V _{CEO} | 70 | | | V |
| | Emitter - Collector Voltage | V _{ECO} | 7 | | | V |
| | Collector Current | I _C | 50 | | | mA |
| | Collector Power Dissipation | P _C | 150 | | 100 | mW |
| Total Power Dissipation | | P _{tot} | 200 | | 170 | mW |
| *1 | Isolation Voltage | V _{iso} | 3,000 | | | V _{rms} |
| Operating Temperature | | T _{opr} | -55 ~ +100 | | | °C |
| Storage Temperature | | T _{stg} | -55 ~ +150 | | | °C |
| *2 | Soldering Temperature | T _{sol} | 260 (10s) | | | °C |

*1. AC For 1 Minute, R.H. = 40 ~ 60%

Isolation voltage shall be measured using the following method.

- (1) Short between anode and cathode on the primary side and between collector and emitter on the secondary side.
- (2) The isolation voltage tester with zero-cross circuit shall be used.
- (3) The waveform of applied voltage shall be a sine wave.

*2. For 10 Seconds

ELECTRICAL - OPTICAL CHARACTERISTICS

(Ta = 25°C)

| PARAMETER | | SYMBOL | MIN. | TYP. | MAX. | UNIT | CONDITIONS |
|--------------------------|--------------------------------------|---------------|--------------------|--------------------|------|----------|---|
| INPUT | Forward Voltage | V_F | — | 1.2 | 1.4 | V | $I_F=20mA$ |
| | Reverse Current | I_R | — | — | 10 | μA | $V_R=4V$ |
| | Terminal Capacitance | C_t | — | 30 | 250 | pF | $V=0, f=1KHz$ |
| OUTPUT | Collector Dark Current | I_{CEO} | — | — | 100 | nA | $V_{CE}=V, I_F=0$ |
| | Collector-Emitter Breakdown Voltage | BV_{CEO} | 80 | — | — | V | $I_C=0.1mA$ $I_F=0$ |
| | Emitter-Collector Breakdown Voltage | BV_{ECO} | 7 | — | — | V | $I_E=10\mu A$ $I_F=0$ |
| TRANSFER CHARACTERISTICS | Collector Current | I_C | 2.5 | — | 30 | mA | $I_F=5mA$ |
| | *1 Current Transfer Ratio | CTR | 50 | — | 600 | % | $V_{CE}=5V$ |
| | Saturated Current | $I_{C(sat)}$ | — | 4.8 | — | mA | $I_F=8mA$ |
| | Saturated CTR | $CTR_{(sat)}$ | — | 60 | — | % | $V_{CE}=2.4V$ |
| | Collector-Emitter Saturation Voltage | $V_{CE(sat)}$ | — | — | 0.4 | V | $I_F=2.4mA$ $I_C=8mA$ |
| | Isolation Resistance | R_{iso} | 5×10^{10} | 1×10^{11} | — | Ω | DC500V 40 ~ 60% R.H. |
| | Floating Capacitance | C_f | — | 0.6 | 1 | pF | $V=0, f=1MHz$ |
| | Response Time (Rise) | t_r | — | 2 | — | μs | $V_{CE}=10V, I_C=2mA$ $R_L=100\Omega$ |
| | Response Time (Fall) | t_f | — | 3 | — | μs | |
| | Turn-On Time | t_{ON} | — | 3 | — | us | |
| | Turn-Off Time | t_{OFF} | — | 3 | — | us | |
| | Turn-On Time | t_{ON} | — | 2 | — | us | |
| | Storage Time | t_s | — | 25 | — | us | $V_{CE}=5V, I_C=16mA$ $R_L=1.9K\Omega$ |
| Turn-Off Time | t_{OFF} | — | 40 | — | us | | |

$$*1 \text{ CTR} = \frac{I_C}{I_F} \times 100\%$$

RANK TABLE OF CURRENT TRANSFER RATIO CTR

| MODEL NO. | RANK MARK | CTR (%) |
|--------------------|---------------------------------------|-----------|
| LTV-217 | A | 80 ~ 160 |
| | B | 130 ~ 260 |
| | C | 200 ~ 400 |
| | D | 300 ~ 600 |
| | A or B or C or D or E or F or No mark | 50 ~ 600 |
| LTV-227 LTV-247 | A or B or C or D or E or F or No mark | 50 ~ 600 |

| | |
|-------------------|---|
| CONDITIONS | $I_F = 5 \text{ mA}$ $V_{CE} = 5 \text{ V}$ $T_a = 25 \text{ }^\circ\text{C}$ |
|-------------------|---|

CHARACTERISTICS CURVES

Fig1. Forward current vs. ambient temperature

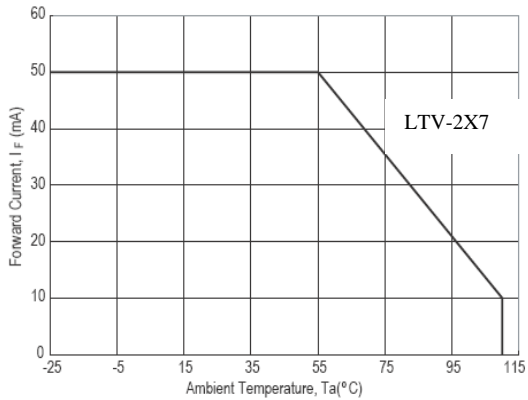

Fig2. Collector power dissipation vs. ambient temperature

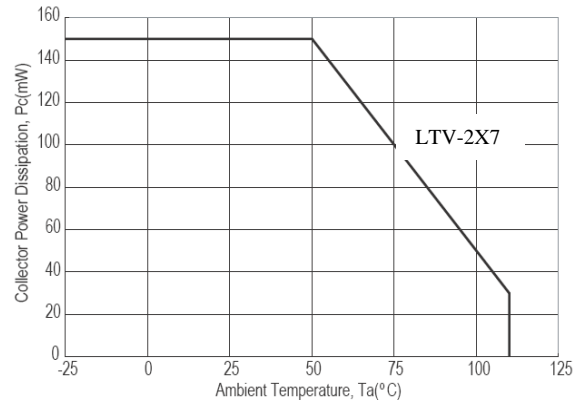

Fig3. Pulse forward current vs. duty cycle

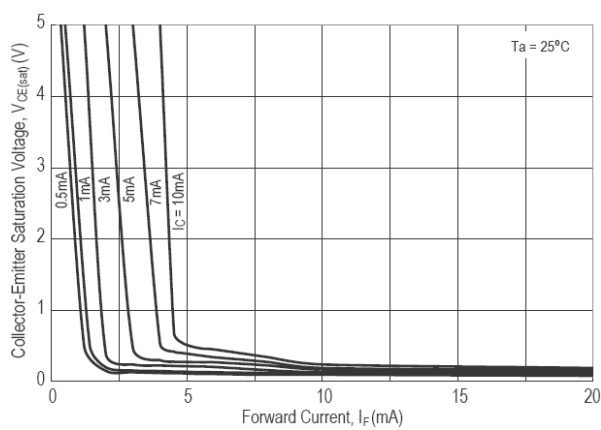

Fig4. Forward current vs. forward voltage

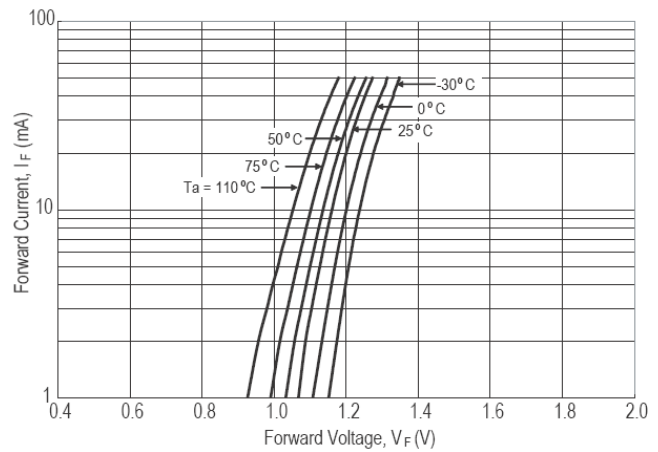

Fig5. Current transfer ratio vs. forward current

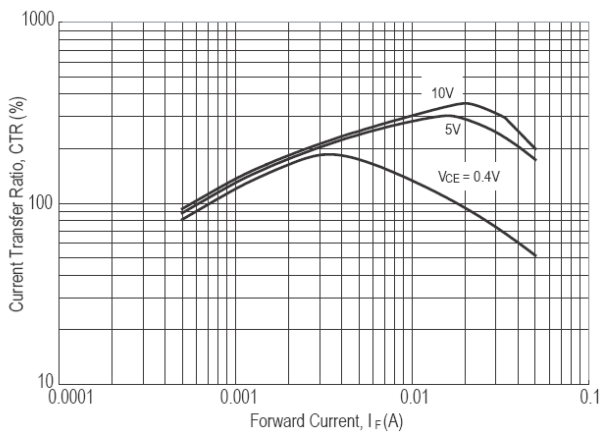
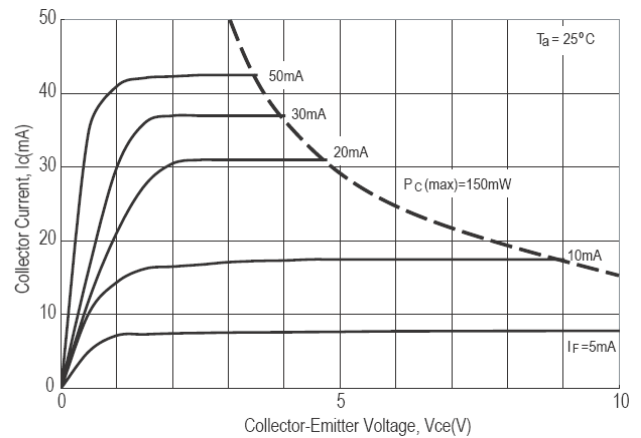

Fig6. Collector current vs. collector-emitter voltage



CHARACTERISTICS CURVES

Fig7. Collector-emitter saturation voltage vs. ambient temperature

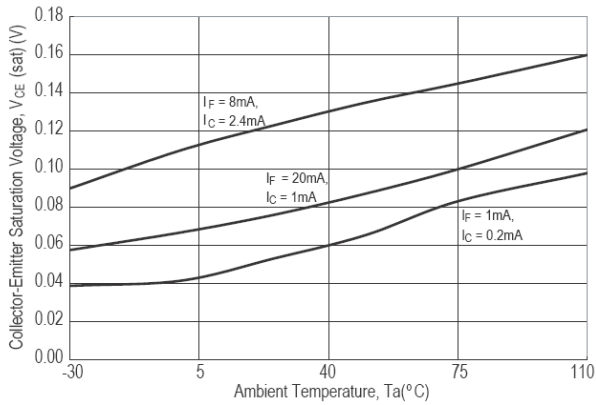
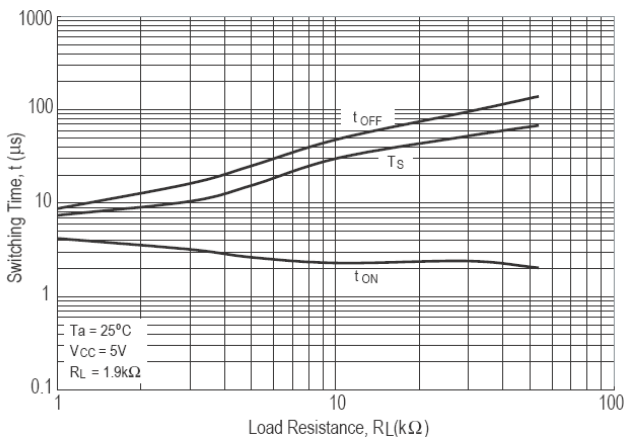

Fig9. Response time vs. load resistance



SWITCHING TIME TEST CIRCUIT

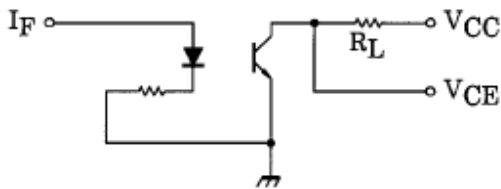

Fig8. Collector dark current vs. ambient temperature

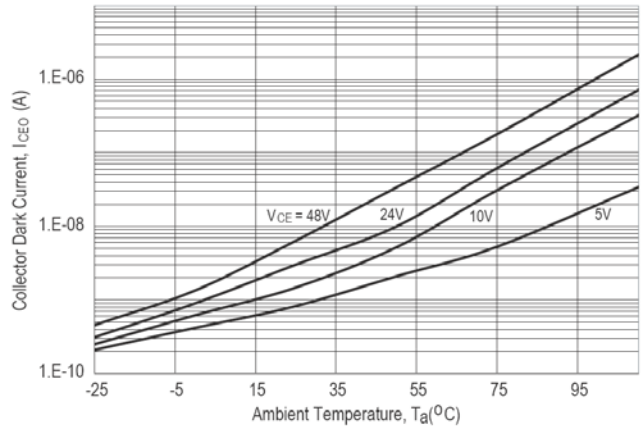
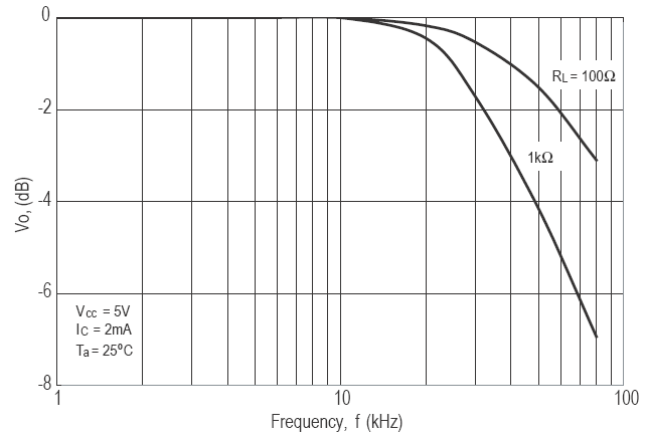
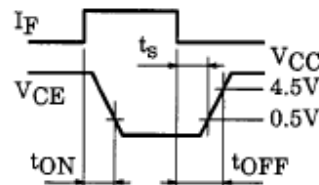
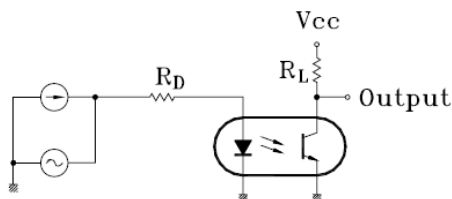

Fig10. Frequency Response



Test Circuit for Frequency Response



Notes:

- Lite-On is continually improving the quality, reliability, function or design and Lite-On reserves the right to make changes without further notices.
- The products shown in this publication are designed for the general use in electronic applications such as office automation equipment, communications devices, audio/visual equipment, electrical application and instrumentation.
- For equipment/devices where high reliability or safety is required, such as space applications, nuclear power control equipment, medical equipment, etc, please contact our sales representatives.
- When requiring a device for any " specific" application, please contact our sales in advice.
- If there are any questions about the contents of this publication, please contact us at your convenience.

The contents described herein are subject to change without prior notice.